

PLASTIVERT
Solide et Durable

OFFICIAL
GOVAPLAST
DEALER

A broad and
sustainable vision:

GOVADECK®
GOVAWALL®

GOVA home+
PLAST

Index

Our story, your future	4
Values	6
An everlasting vision	7
23 reasons	8
Our mission	10
Govadeck®	12
Cases	22
Govawall®	34

“

ONCE IS NOT ENOUGH
the importance of recycling.

Recycling waste today is still a choice.
Tomorrow it will be a necessity.

For several years now, Govaplast has been proving that a durable solution for the growing plastic waste stream does exist. With continuous growth for more than 50 years, global world plastics production has risen from 1.7 million tonnes in 1950, to 288 million tonnes in 2012. This is a striking figure...

European production alone accounts for about 57 million tonnes of this total amount.

25 million tonnes of plastics ended up in the waste stream in 2012 of which 6.6 million tonnes were used in recycling.

We are pleased to take part in this cycle, with durable and recyclable products as a result.

”

Govaerts Recycling Team

Our story, your future

since 1995

We started our production in 1995 from scratch with no experience at all in the recycling sector.

But we learned fast and expanded fast from a single production unit into an extended machinery park. We could easily say that innovative ideas and a lot of guts brought us where we are standing now, being the market leader in the production of sustainable products in recycled plastic.

NL: Ons verhaal, uw toekomst

Bij de oprichting van Govaerts Recycling nv in 1995 hadden we helemaal geen ervaring in de recyclingsector. We leerden echter snel waardoor onze productie-eenheid al gauw uitgroeide tot een groot machinepark. Dankzij een mix van voortdurende vernieuwing en flink wat lef, zijn we vandaag marktleider in de productie van duurzame producten in gerecycled plastic.

FR: Notre histoire, votre futur

Partis d'une feuille blanche en 1995, sans aucune expérience du secteur du recyclage, nous sommes devenus leader du marché pour la fabrication de produits en plastique recyclé. Nous avons vite appris et nous sommes rapidement passés d'une seule unité de production à un parc étendu de machines. Quelques idées innovantes et un peu d'audace nous ont conduits là où nous sommes aujourd'hui, soit leader du secteur.

DE: Unsere Geschichte, Ihre Zukunft

1995 begannen wir unsere Produktion von Null und ohne jedwede Erfahrung im Recyclingsektor. Aber wir haben schnell gelernt und konnten uns rasch von einer einzelnen Produktionseinheit zu einem umfassenden Maschinenpark vergrößern. Innovative Ideen und viel Mut haben uns dahin gebracht, wo wir heute stehen: Marktführer bei der Produktion nachhaltiger Produkte aus recyceltem Kunststoff.

Values

Innovation

Govaerts Recycling always aims to be at the forefront of innovation when it comes to product development, design and manufacturing processes. We are constantly looking to meet our customer's needs and to adapt our products to the latest requirements.

Quality

Our products have been tested by independent specialists, with good results, emphasizing the importance to supply top quality. This is translated into a 10 year guarantee on the material.

NL: Innovatie

Govaplast wil een voortrekkersrol spelen op het vlak van innovatie. Wij ontwikkelen vernieuwende producten met een eigentijds design volgens de allernieuwste productieprocessen. Daarbij staan de veranderende wensen en behoeften van onze klanten steeds centraal.

Kwaliteit

Onze producten zijn stuk voor stuk getest door onafhankelijke vakspecialisten. De goede resultaten beklemtonen ons voortdurende streven naar hoogstaande kwaliteit. We hebben vertrouwen in onze producten. Daarom ook bieden we altijd tien jaar garantie op ons materiaal.

FR: Innovation

Govaplast désire toujours être à la pointe de l'innovation en matière de développement de produits, de design et de processus de fabrication. Nous veillons scrupuleusement à répondre aux besoins de notre clientèle. Pour cela, nous n'hésitons jamais à conformer nos produits aux exigences actuelles et futures.

Qualité

Nous avons confié les tests de nos produits aux meilleurs spécialistes indépendants dans le souci d'une amélioration permanente de la qualité. Ces tests nous permettent de vous accorder une garantie de 10 ans sur le matériel.

DE: Innovation

Govaplast strebt danach, Innovationsführer bei Produktentwicklung, Design und Herstellungsprozessen zu sein. Wir wollen die Bedürfnisse unserer Kunden immer erfüllen und passen unsere Produkte den Wünschen und Bedürfnissen an.

Qualität

Unsere Produkte wurden von unabhängigen Spezialisten mit guten Ergebnissen geprüft. Dabei zeigt sich wieder einmal, wie wichtig es ist, Spitzenqualität zu liefern. Dieses findet sich wieder in der Garantie von 10 Jahren auf das Material.

An everlasting vision

Cradle to cradle

The protection of the environment has always been our focal point. Govaplast wishes to play an active role in the entire recycling process, thus contributing to the protection of our eco system.

Our production process is a perfect example of the cradle-to-cradle philosophy: we use recycled material and our end products are 100% recyclable again. We use 'green' power and re-use our cooling-water, reducing our ecological footprint.

A sophisticated production process and the use of high-grade raw materials enables us to produce and supply high-quality products. The raw material consists of 100% plastic recycled material (PE and PP).

NL: Cradle to cradle

Govaplast wil van a tot z een actieve rol spelen in het recyclingproces, en op die manier bijdragen aan het behoud van ons ecosysteem.

Ons productieproces is een schoolvoorbeeld van de cradle-to-cradle filosofie die wij hanteren. We gebruiken niet alleen gerecyclede materialen, ook onze eindproducten zijn opnieuw 100% recyclebaar. We gebruiken groene energie en hergebruiken ons koelwater om zo onze ecologische voetafdruk te verkleinen.

Dankzij ons geavanceerde productieproces en het gebruik van hoogwaardige grondstoffen kunnen wij producten van topkwaliteit maken en leveren. Onze grondstoffen bestaan voor 100% uit gerecycled plastic (PE en PP).

FR: Cradle to cradle

La protection de l'environnement est depuis toujours notre préoccupation principale. Govaplast a un rôle actif dans l'ensemble du processus de recyclage et l'entreprise contribue à la protection de notre planète. Pour y arriver, nous suivons la philosophie cradle to cradle, nous utilisons de la matière recyclée et nos produits finis sont, à leur tour, recyclables à 100%.

Notre usine consomme de l'énergie « verte » et utilise l'eau de refroidissement en circuit fermé, réduisant ainsi notre empreinte écologique.

Le processus original de production et l'utilisation de matières premières d'excellente qualité fournissent des produits haut de gamme à base de 100% de matières plastiques recyclées (PE et PP).

DE: Cradle to cradle

Der Schutz der Umwelt lag uns schon immer am Herzen. Govaplast will im gesamten Recyclingprozess eine aktive Rolle spielen und so zum Schutz unseres Ökosystems beitragen.

Unser Produktionsprozess ist ein perfektes Beispiel für die Cradle-to-Cradle-Philosophie: Wir verwenden recyceltes Material und unsere Endprodukte selbst sind auch wieder 100% recycelbar. Wir verwenden „grünen“ Strom und auch unser Kühlwasser wird wiederverwendet. So reduzieren wir unseren ökologischen Fußabdruck.

Ein anspruchsvoller Produktionsprozess und die Verwendung von hochwertigen Rohstoffen erlauben uns, qualitativ hochwertige Produkte herzustellen und zu liefern. Die Rohstoffe bestehen zu 100% aus recyceltem Kunststoffmaterial (PE und PP).

All advantages at a glance

23 REASONS
why we think this is a
WONDERFUL PRODUCT



Résistant aux chocs



Texture naturelle



Facile à travailler



Teinté dans la masse



Sans écharde



Recherche ingénierie



Non absorbante



Repositionable facilement



Noyau solide



8 couleurs



Résistant aux UV



Systématiquement testé



Complètement recyclé



Nombreux profils différents



100 % de dechet plastique



Imperméable



Matériau antidérapant



Garantie de 10 ans
sur nos profils



Sans entretien



Flexible



Eternel



Imputrescible



Resistant aux graffiti

There's around 25 million tons of waste in Europe. 10 million tons of this amount is pure plastic disposal, 8,7 million tons can be recovered for energy and only 6 million tons is being recycled today.

“ Our mission is to contribute
TO MAKE THIS BETTER

We make the
SWITCH FROM WASTE TO QUALITY products.

Let us inspire you to
MAKE THIS SWITCH OF MINDSET too ”



100%
RECYCABLE
products



315 million
RECYCLED
**PLASTIC
BOTTLES**
used last year



14 400 km
PROFILES
produced
IN 1 YEAR



**PP - LDPE
& HPDE**
makes our
IDEAL MIX



**DEALER
NETWORK**
23 over
COUNTRIES



**AWARD
WINNING**
products



NON production
STOP
24/7



every **m²** **DECKING**
CONTAINS
920 **PLASTIC**
bags **SHOPPING**



1.

GOVADECK® system

A well thought-out decking system including bearing construction and fasteners, for private gardens as for public projects as well.

NL: Een doordacht terrasysteem inclusief onderconstructie en bevestigingsmateriaal, zowel voor privé tuinen als voor openbare projecten.

FR: Un système de terrasse bien réfléchi, construction portante et éléments de fixation inclus, pour des jardins privés ainsi que pour des projets publics.

DE: Ein wahlgedachtes Terrassensystem, Unterkonstruktion und Befestigungsmaterial einbegriffen, für Privatgärten sowie öffentliche Projekte.



The anti slip and
splinter proof profiles
make this
THE PERFECT DECK
without a hollow
walking sound

Solid and durable

Govadeck solid anti-slip boards are made of durable material and they are designed to last.

Not only are they strong and **MAINTENANCE FREE**, their natural appearance enables them to **BLEND** into and enhance any setting.

NL: Sterk en duurzaam

Onze massieve antislipplanken uit duurzaam Govaplast materiaal, zijn weerbestendig en rotvrij. Ze zijn niet enkel sterk en onderhoudsvrij, met hun natuurlijke look passen ze ook in elke omgeving.

FR: Solide et durable

Les planches de terrasse antidérapantes en matière durable Govaplast, sont imputrescibles et résistantes aux intempéries. Elles sont solides et d'une grande longévité, et grâce à leur aspect naturel, elles s'inscrivent toujours bien dans l'ensemble.

DE: Stark und langlebig

Unsere rutschfesten Terrassenbretter aus langlebigem Govaplast Kunststoff, sind verrottungsbeständig und witterungsfest. Sie sind nicht nur solide und pflegefrei, sie fügen sich durch ihr natürliches Aussehen vorzüglich in jede Umgebung ein.

These boards are
DESIGNED AND ENGINEERED
for the long run

Unique product









Production lengths
30 x 150 x 3600 mm

Concealed fitting system

Finishing border
30 x 82 x 3600 mm

Colors

-  Sand Brown
-  Basalt Brown
-  Atlas Beige
-  Mineral Grey
-  Ash Grey
-  Ural Black

Same board, 2 looks

Upside down or downside up,
just choose the look you like.



1 CLASSIC look

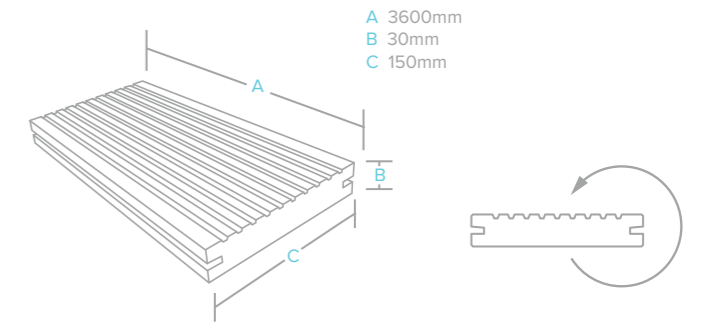

2 SMOOTH look

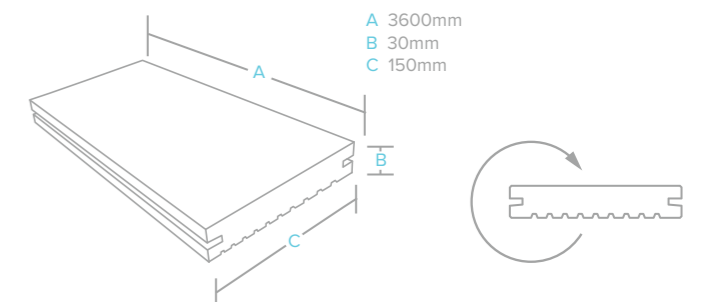



Easy installation

A Govadeck decking can be installed yourself. The bearing construction consists of **ROT PROOF** plastic beams. Our **OWN INVISIBLE FASTENING SYSTEM** (clips and screws) is placed in the lateral grooves, supporting the boards and allowing them to expand in a controlled way as well.

Your decking is maintenance free and does not require any treatment at all.



NL: Eenvoudige plaatsing

Een Govadeck terras kan zelf geplaatst worden. De onderconstructie bestaat uit rotvrije kunststof balken. Ons eigen bevestigingssysteem (klemmen en schroeven) wordt in de gleuven geplaatst, zodat de planken goed ondersteund worden en tegelijkertijd de mogelijkheid hebben om gecontroleerd uit te zetten. Uw terras vergt geen onderhoud en moet niet met beschermingsproducten behandeld worden.

FR: Pose par vous même

Une terrasse Govadeck peut être posée par l'utilisateur même. La construction portante comprend des poutres en plastique imputrescible. Notre propres éléments de fixation (clips et vis) s'emboîtent dans les rainures, de sorte que les planches sont bien supportées et qu'elles peuvent se dilater de façon contrôlée. Votre terrasse ne demande aucun entretien et il est donc inutile de la traiter avec de produits de protection ou d'entretien.

DE: Selbstmontage

Eine Govadeck Terrasse können Sie auch selbst verlegen. Unsere handliche Verlegeanleitung hilft dabei. Die Unterkonstruktion besteht aus verrottungsbeständige Balken. Unser eigenes Befestigungssystem (Halter und Schrauben) wird in die Nut des Brettes geschoben, um die Bretter die notwendige Unterstützung zu bieten und das produktspezifische Ausdehnungsverhalten zu berücksichtigen. Ihre Terrasse ist absolut unterhaltsfrei, Schutzmittel sind nicht mehr notwendig.



The finishing touch, thanks to
THE EDGING BOARD.



CASES

A selection of projects illustrating Govaplast as a multi-purpose decking material.

NL: Een selectie van realisaties die aantonen dat Govaplast in verschillende situaties toegepast kan worden.

FR: Une sélection de réalisations montrant plusieurs applications avec Govaplast.

DE: Eine Auswahl von Projekten die verschiedene Einsatzgebiete Govaplasts illustrieren.

NOT ONLY FOR PATIOS

This product is engineered
to be used on pontoons,
bridges, boardwalks...



Some like it
SMOOTH AND SLEEK





Some look for the
ROMANTIC FEEL

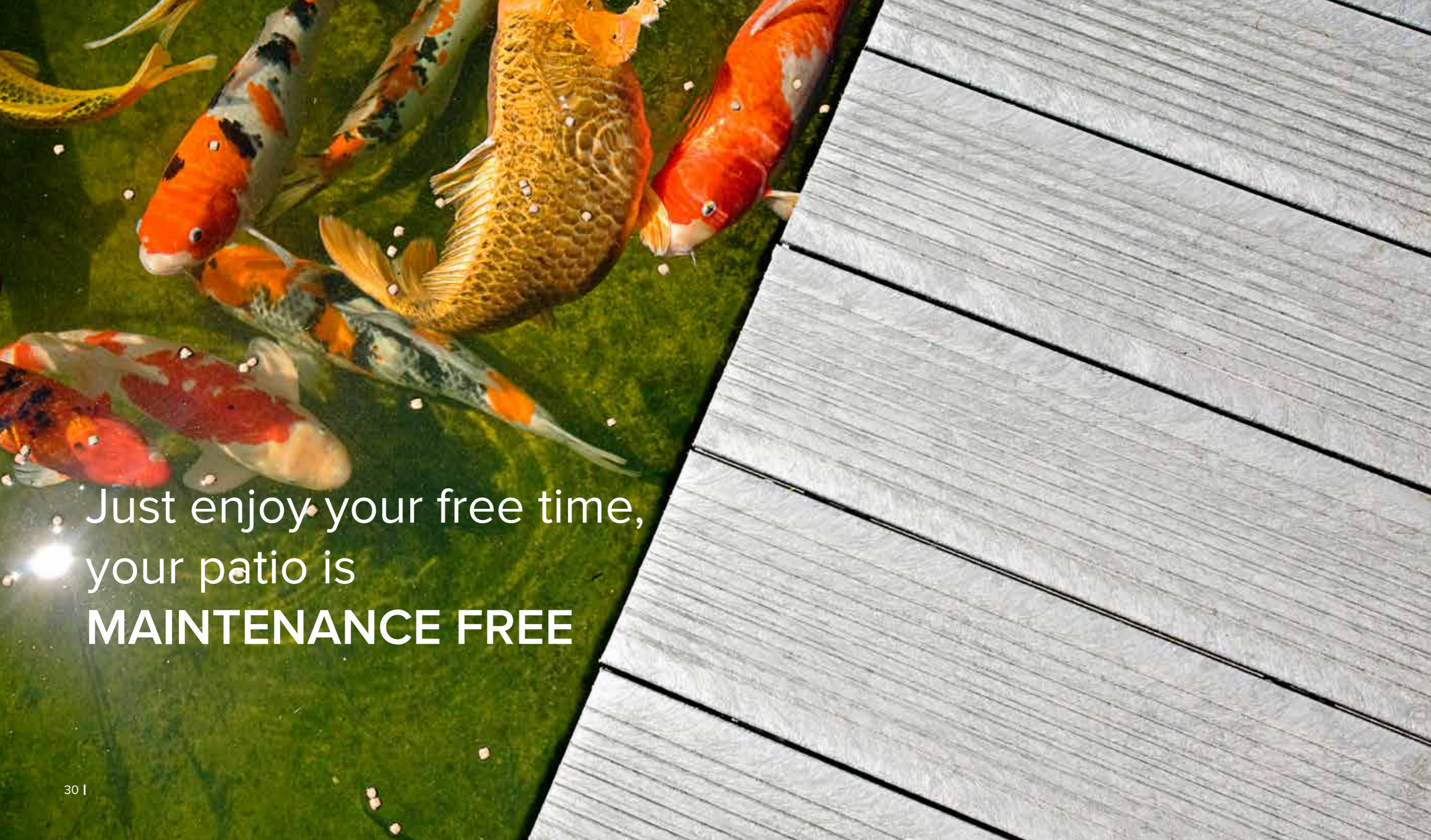

Just enjoy your free time,
your patio is
MAINTENANCE FREE





The perfect choice
for swimming pools because it's
NON-ABSORBENT and **ANTI-SLIP**





2.

GOVAWALL® collection

Govawall is a close board
fencing system with focus on
sustainable privacy

*NL: Govawall is een tuinafsluiting die garant
staat voor duurzame privacy.*

*FR: Govawall est un système de clôture de
jardin opaque et durable.*

*DE: Govawall ist eine langlebige
Sichtschutzwand für Ihre Privatsphäre.*



Solid and durable

Govawall consists of solid posts and boards, combined with **ALUMINUM MOUNTING** and **FINISHING PROFILES**.

The result is a strong fencing system that keeps its appearance and form in all seasons.

NL: Sterk en duurzaam

Govawall bestaat uit massieve palen en planken. Samen met de aluminium montage- en afwerkingsprofielen vormen zij een sterke tuinafsluiting die in alle weersomstandigheden zijn vorm en uiterlijk behoudt.

FR: Solide et durable

Govawall est constitué de piquets et planches solides. En plus des profils de montage et de finition en aluminium sont utilisés, créant une palisade résistante à toutes les conditions climatiques.

DE: Stark und langlebig

Govawall wird aus massiven Pfosten und Brettern zusammen mit aluminium Montage- und Abdeckprofile aufgebaut, damit die Sichtschutzwand bei unterschiedlichen Witterungsverhältnisse ihr Aussehen und ihre Form behält.

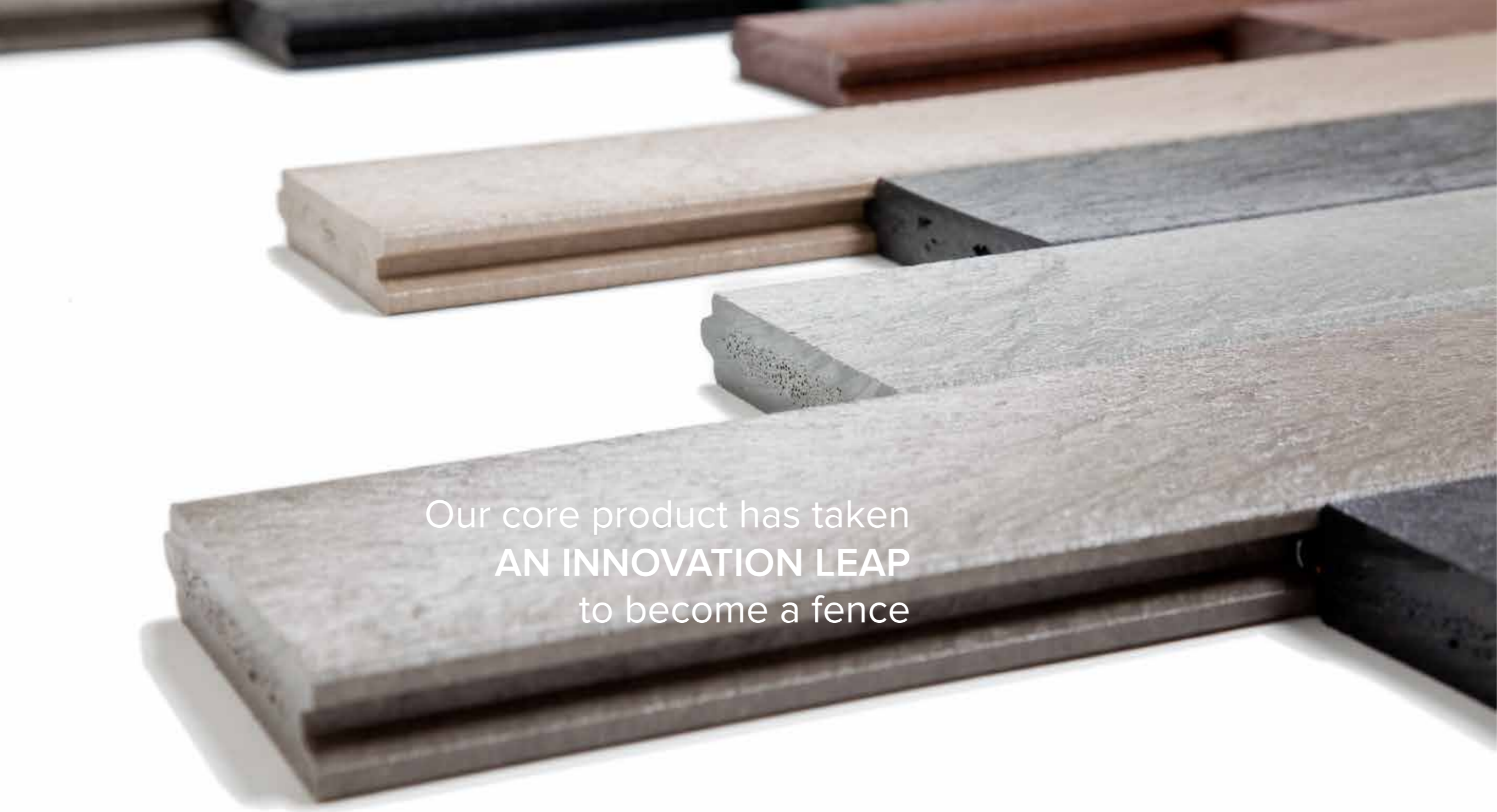

Our core product has taken
AN INNOVATION LEAP
to become a fence

Unique product







Length
200 cm

Thickness
2.8 cm

Height
180 cm or 200 cm

Colours boards

-  Sand Beige
-  Basalt Brown
-  Atlas Beige
-  Ash Grey
-  Ural Black



Quality, NO MAINTENANCE

Govawall contains no wood and distinguishes itself from other fencing systems for its maintenance free material. Govawall's solid boards will also create a **NOISE BARRIER** where required. Moreover its natural appearance and neutral colours enables Gova-Wall to blend into any setting.

NL: Kwaliteit zonder onderhoud

Govawall tuinschermen bevatten geen hout en onderscheiden zich van alle andere bestaande systemen dankzij de onderhoudsvrije eigenschappen van het materiaal.

Ze creëren een gevoel van privacy en vormen eveneens een goede geluidsbarrière. Bovendien passen ze met hun natuurlijke look en neutrale kleuren probleemloos in elke omgeving.

FR: Qualité sans entretien

Govawall ne contient pas de bois et se distingue de tous les autres systèmes existants car il ne nécessite aucun entretien.

Govawall renforce l'intimité de votre jardin grâce à son opacité totale et consiste une excellente barrière anti-bruit. Les couleurs disponibles, assez neutres, s'accordent naturellement avec l'environnement.

DE: Qualität, wartungsfrei

Govawall Sichtschutzwände enthalten kein Holz und unterscheiden sich von allen anderen Systemen durch die Pflegeleichtigkeit des Materials.

Die Wände verstärken die Geborgenheit in Ihrem Garten und bieten ausserdem einen hervorragenden Lärmschutz. Durch das natürliche Aussehen und die neutralen Farben fügt sich Govawall optimal in jede Umgebung ein.

Unique design and color

Our handy instructions manual will be
YOUR INSTALLATION GUIDELINE.

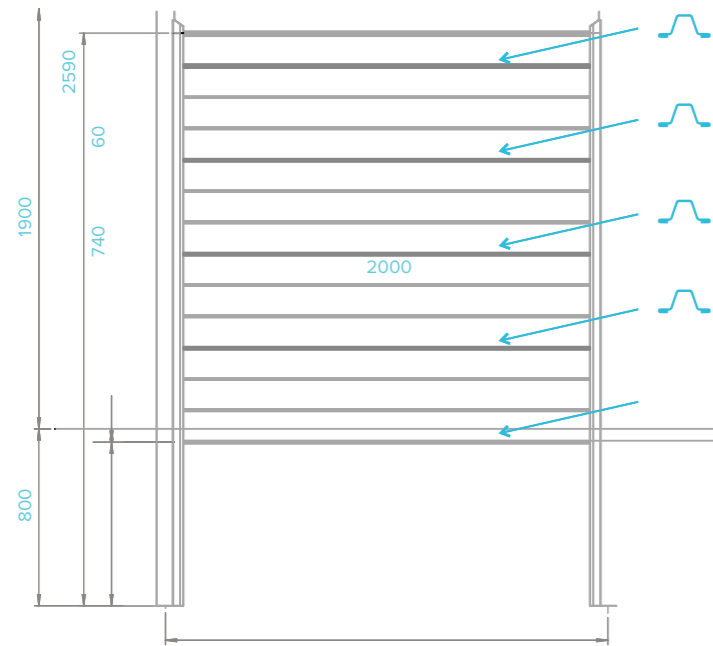

13 boards
with 5 fortification profiles 

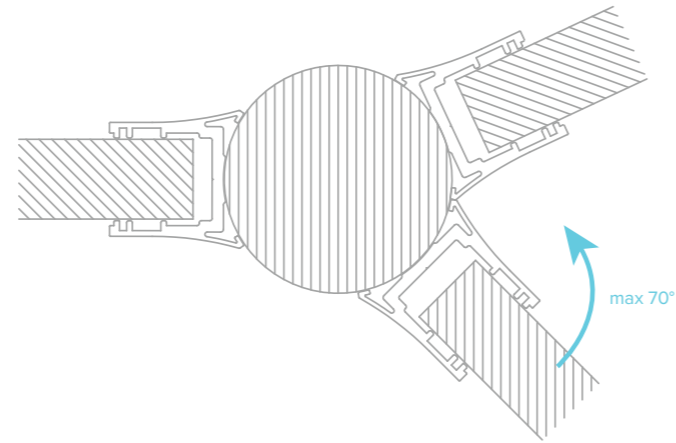

Angle
between 70° and 290°

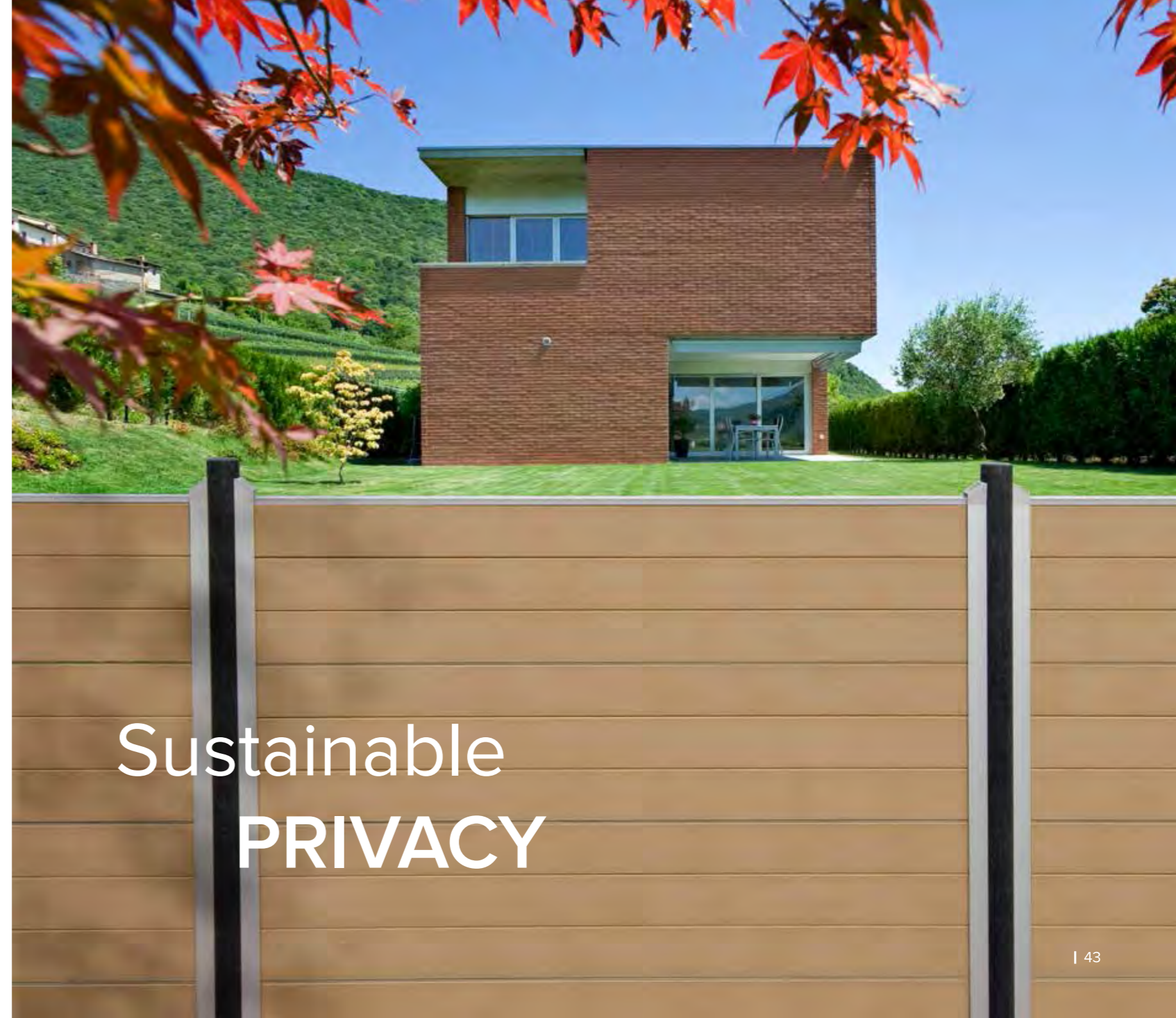

Sustainable
PRIVACY

Easy installation

Ø diam. 80mm

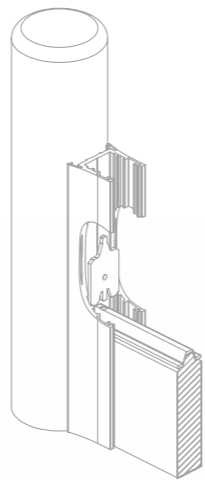

Top
(during installation)
gova clip +
gova-set-screw

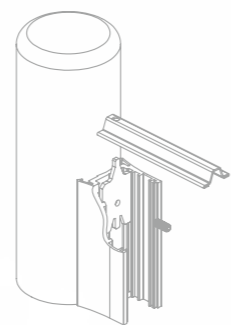

Top
(during installation)
Gova clip

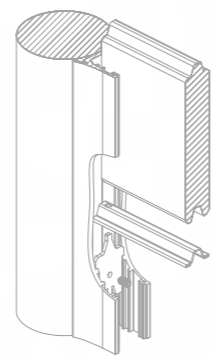

Bottom
(during installation)
gova clip +
gova-set-screw

The **ALUMINUM** profiles can
be fixed onto
the posts in an angle
BETWEEN 70° AND 290°

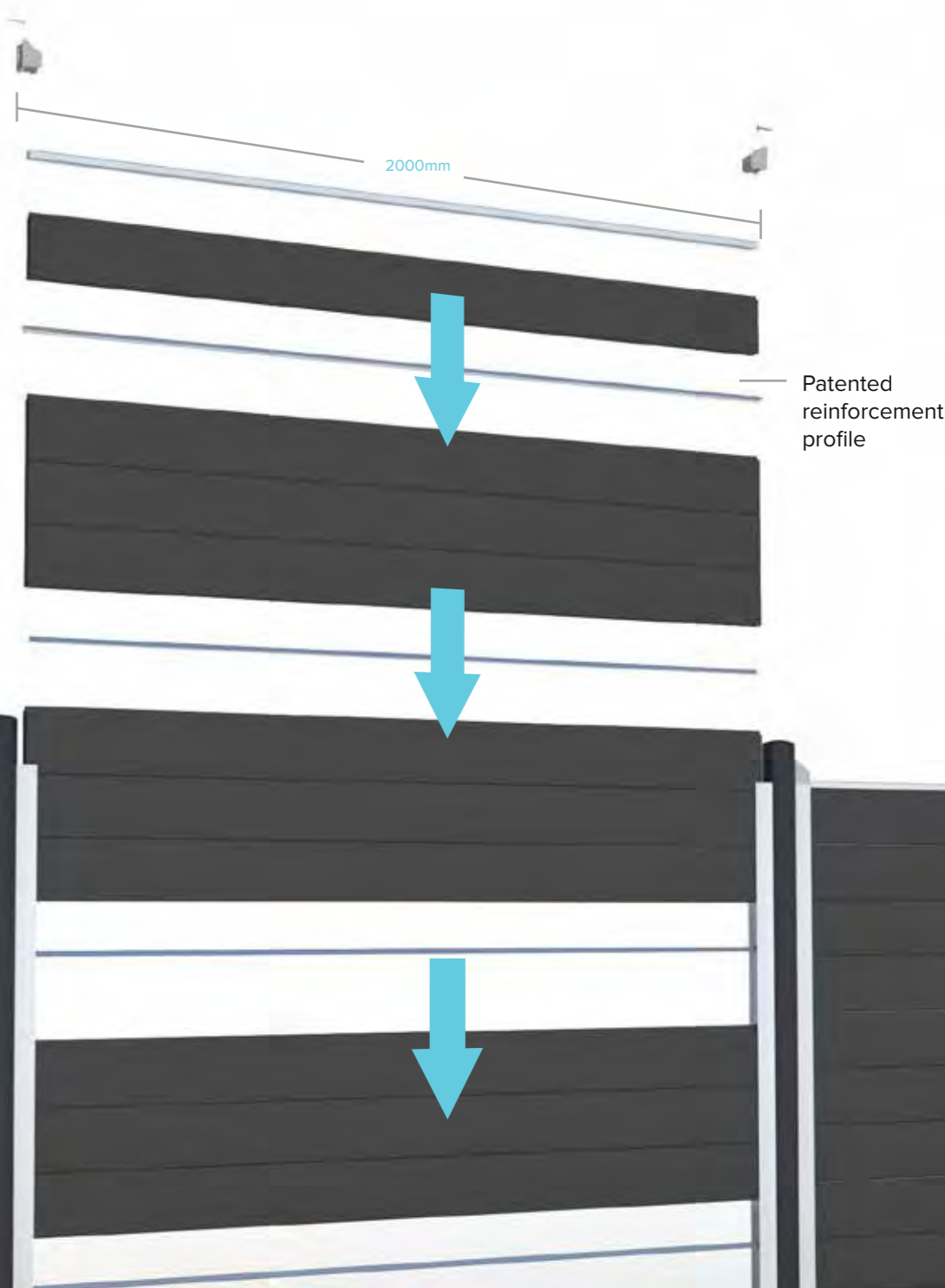

Discover our wide product range

GOVA[®]
PLAST
Switch to Quality

Boards
Sheets

GOVA[®]street
PLAST

Benches
Tables
Planters
Litter bins
Traffic items

GOVA[®]horse
PLAST

Stable boards
Rubber tiles

GOVA[®]play
PLAST

Play Objects
Play Furniture
Fall protection

Govaplast
Industriepark Kolmen
Kolmenstraat 1324
B-3570 Alken

info@govaplast.com
www.govaplast.com

PLASTIVERT

Solide et Durable

56, rue de la Fuie - 79180 Chauray
07 60 12 40 30

www.plastivert.com

OFFICIAL
GOVAPLAST
DEALER

